



# 30RAM

MODULAR AIR-COOLED CHILLER



## Turn To The Experts

Carrier is a leading global provider of innovative HVAC, refrigeration, fire, security and building automation technologies.

Supported by the iconic Carrier name, the company's portfolio includes industry-leading brands such as Carrier, Kidde, Edwards, LenelS2 and Automated Logic.

Carrier's businesses enable modern life, delivering efficiency, safety, security, comfort, productivity and sustainability across a wide range of residential, commercial and industrial applications.



In 1998, Time magazine named Dr. Carrier one of its 20 most influential builders and titans of the 20<sup>th</sup> century.



## PRODUCT NOMENCLATURE



The modular air-cooled chiller (heat pump) unit is a central air conditioning using the air as cold & heat source and the water as refrigerant carrier, which can be integrated with various air side units such as fan coil unit, air handling unit to form a central air conditioning system. With 115 years of experience in R&D, design and application, Carrier constantly launches new environment-friendly modular units, which improves the structures, systems and programs based on original products, and designs special series of comfortable and technological units. The environment-friendly modular unit has complete functions and various specifications, with basic modules of any combination available for different models, including 66kW, 100kW, 130kW, and at most 8 modules can be connected in parallel, providing combination products of 66kW- 2080kW. The unit is easy to install, with a system without cooling water, with simple pipelines, moderate cost, short construction period, allowing staged investment, widely applied in such commercial, industrial and civil buildings as villas, hotels, hospitals, office buildings, restaurants, supermarkets, movie theaters.

30RAM 201

201: Specification code

30RAM : Modular air-cooled chiller

## R410A CLASSICAL MODULAR UNIT

The new generation of X series environment-friendly modular air-cooled unit is based on years of experience in R&D and design, which is greatly improved in aspects of the structure, system and microcomputer control technology, providing wider operation range of refrigeration and heating, and higher adaptability to applications with requirements on comfort and technology. There are basic modules of any combination available for different models, including 66kW, 100kW, 130kW, and at most 16 modules can be connected in parallel, providing combination products of 66kW - 2080kW.

### Excellent Capacity

---

Units of the same model or different models can be combined freely. Each group can combine up to 8 modules.



### Free master Module Design

---

Any single unit can operate as the master once connected with the wired controller. It overcomes the problem that the whole system would fail to work properly when the fixed master unit malfunctions.

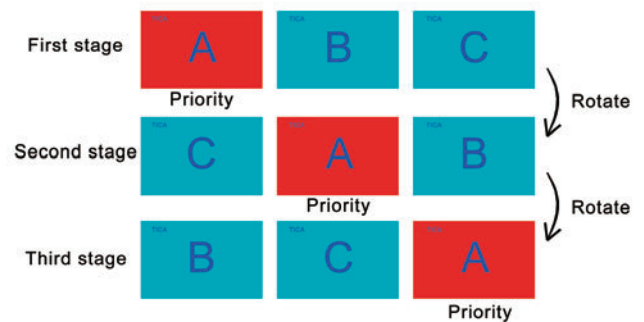

## Intelligent Defrosting Technology, Non-stop When Defrosting

The unit control system can determine whether defrosting is necessary according to the ambient temperature in heating mode, evaporating temperature and running time; when defrosting conditions are met, the unit will automatically activate the defrosting program to complete defrosting within a short time and provide heating operation efficiency up to over 90% , ensuring the optimum heating capacity and high EER.

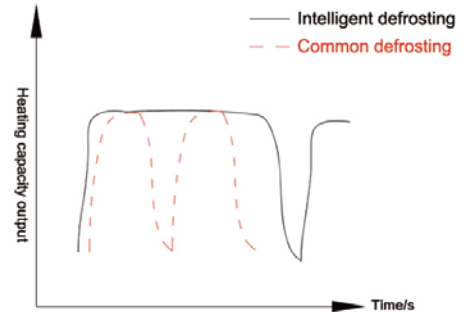

## Intelligent Air Volume Management

The shared duct system is adopted to greatly expand the operating range. The single-module unit can automatically increase or reduce fans based on the ambient temperature to achieve optimal matching between air volume and load and deliver outstanding performance.



## Intelligent Energy Management Technology

Unique intelligent energy regulation technology in multi-module combination ensures that each module loads or unloads a refrigerant circuit before loading or unloading other refrigerant circuits in the single module, thereby providing higher efficiency, stability and IPLV.

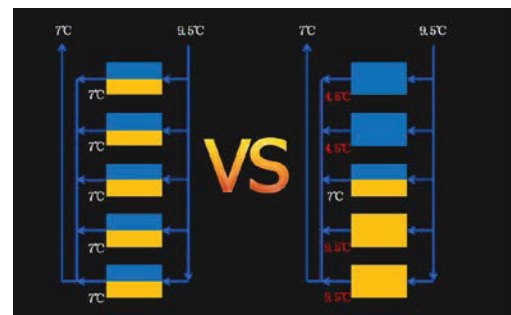

## Widely Operation Range

Low temperature cooling  
5°C- 48°C  
High temperature heating  
-15°C- 48°C

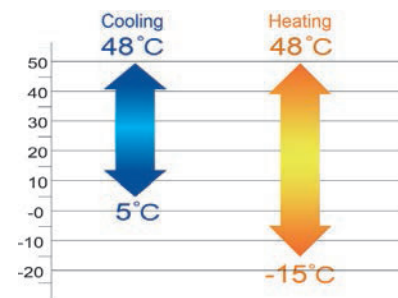

## Compact Design And Smaller Footprint

Unique and compact structure results in small size and occupied area, significant reductions in installation space and cost; the unit is compact and easy to install. A 130KW unit covers floor space of only 2.42m<sup>2</sup>, a 50% reduction compared to its equivalents.

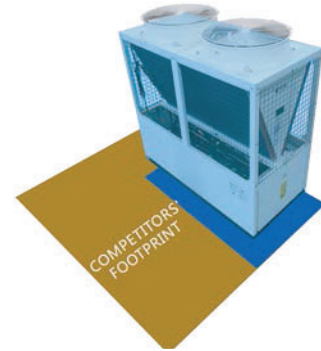

## Reliable Hermetic Scroll Compressor

Unit adopt Reliable hermetic scroll compressor, which is high-efficient, energy saving and operates stably, with low noise, slight vibration and long service life.

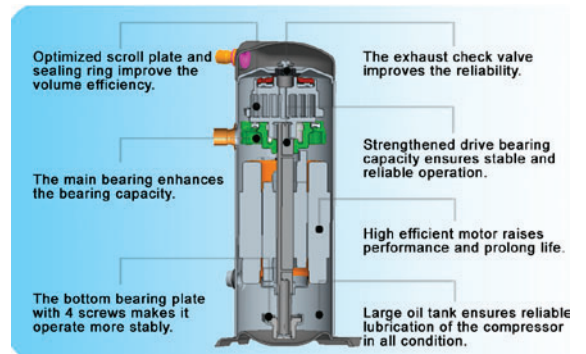

## V-Shaped Condenser

The v-shaped condenser has used an integral reinforcing metal frame, internal thread and triple anti-frosting features (patented design of open-window hydrophilic aluminum foil + bottom elevated + one-way valve), providing higher structural stability and corrosion resistance; with heat exchange efficiency improved through full use of heat exchange area, low tendency to dust accumulation and frosting in winter, low loss of pressure, smoother drainage and higher reliability.

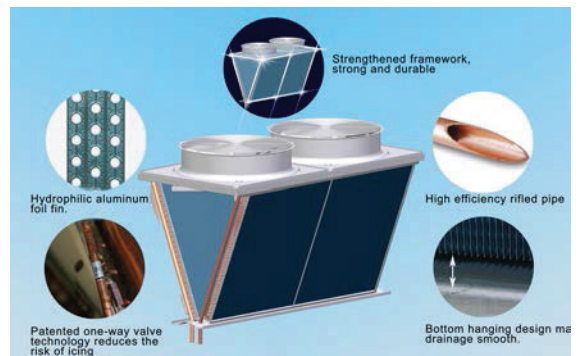

## Efficient Shell And Tube Heat Exchanger

The waterside efficient shell and internal thread heat exchanger is of helical baffle type, with better heat transfer performance and higher resistance to freezing than plate heat exchanger, lower water resistance and lower requirements for water quality.

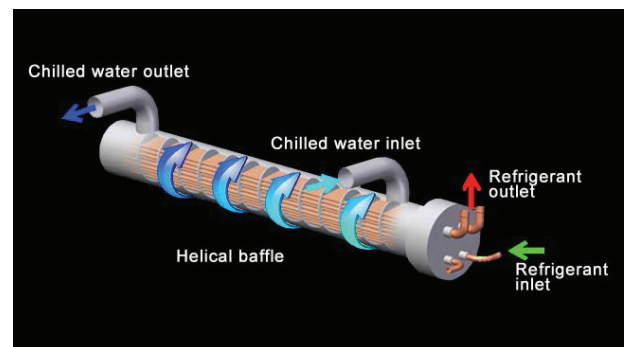

## Saw-shaped Condenser Fan Blades

---

Compared to plastic impellers, the saw-shaped condenser fan blade provide large air volume, high durability and high air supply efficiency with low noise.



## High Precision Electronic Expansion Valve

---

The electronic expansion valve achieves 480 regulating range, supplemented by Carrier's patented precision throttle control technology to realize dynamic matching in refrigerating system, fully improve the optimum efficiency of each component and ensure the optimum condition of system operation pressure and temperature.

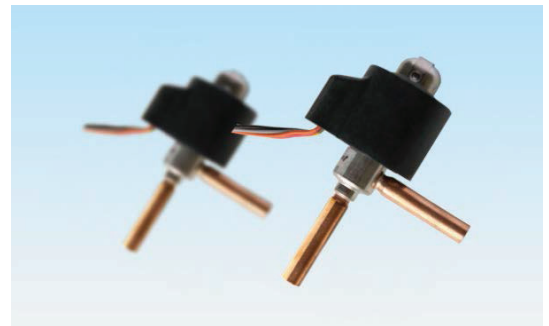

## In House Engineered Microprocessor Control

---

Carrier control panel is fully upgraded based on original control panels with years of experience in R&D and design, which combines more functions including phase sequence detection, current detection, RS-485 communication interface, delivering stronger performance, utility, standardization, convenience and universality. The USB interface is also provided to facilitate later-stage maintenance and upgrade of control function. The panel is supplemented by Carrier developed control program which offers full operation control and multiple safety protection functions.

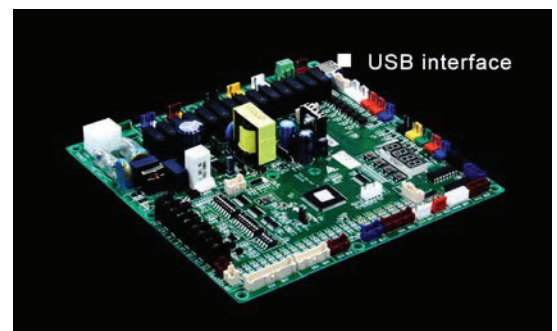

## Multiple Protection Functions, Providing Safety And Reliable

---

The unit has multiple safety protection functions which ensure safety and stable operation of the unit and systems. The water flow switch and multiple anti-freezing program designs protect the unit and systems in an all-round way.

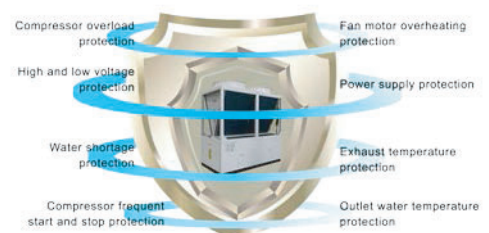

## Specifications

Model			30RAM201	30RAM401
Power supply		V-ph-Hz	380-3-50	380-3-50
Cooling	Cooling capacity	kW	66	130
	Cooling power input	kW	21.29	41.9
	Cooling current	A	37.9	75.5
Maximum power input		kW	30.2	57.6
Maximum input current		A	50	100
Starting current		A	172	266.1
Energy regulation		%	0-50-100	0-50-100
Compressor	Type	-	Hermetic scroll compressor	
	Qty	-	2	2
Evaporator	Type	-	High-efficiency shell-and-tube heat exchanger	
	Water flow	m <sup>3</sup> /h	11.4	22.4
	Water pressure drop	kPa	45	45
	Connection pipe dimension	-	DN65 (Flange)	
Fan	Qty	-	2	2
	Air flow	m <sup>3</sup> /h	28000	48000
	Current	A	2.35	5.3
	Power	kW	1.13	2.2
Unit dimensions (L*W*H)		mm	2200×860×2000	2200×1100×2205
Packaging dimensions (L*W*H)		mm	2260×920×2000	2260×1160×2205
Net weight		kg	570	850
Operating weight		kg	630	950
Refrigerant	Type	-	R410A	R410A

\*CE: 380-400V/3N/50Hz

## Combined Capacity Parameter Table

Model and modular quantity	30RAM201	1	2	3	4	5	6	7	8	9	10	11	12	13	14	15	16
Cooling capacity	kW	66	132	198	264	330	396	462	528	594	660	726	792	858	924	990	1056
Water flow volume	m <sup>3</sup> /h	11.4	22.8	34.2	45.6	57	68.4	79.8	91.2	102.6	114	125.4	136.8	148.2	159.6	171	182.4

Model and modular quantity	30RAM401	1	2	3	4	5	6	7	8	9	10	11	12	13	14	15	16
Cooling capacity	kW	130	260	390	520	650	780	910	1040	1170	1300	1430	1560	1690	1820	1950	2080
Water flow volume	m <sup>3</sup> /h	22.4	44.8	67.2	89.6	112	134.4	156.8	179.2	201.6	224	246.4	268.8	291.2	313.6	336	358.4

Model	Cooling capacity	Compressor Number	Circulation loop	Main Board Number	Maximum Combination Number	Maximum Combination Capacity
30RAM201	66	2	2	1	16	1040
30RAM401	130	4	2	1	16	2080

### ★ Notes:

1. Nominal cooling operating conditions: leaving water temperature 7°C, ambient temperature 35°C; Nominal heating operating conditions: leaving water temperature 45°C, outdoor dry bulb temperature 7°C, wet bulb temperature 6°C.
2. In actual use, the cooling/heating loss should be considered after the installation of the system piping, pumps, valve, dirt, etc. about 6%.
3. For other working conditions or capacity parameters, Please contact Carrier offices for cooling ambient condition under 5°C.
4. There will be no further notice if the parameters changes due to product optimization.
5. The units of the same model or different models can be combined freely. Each system can combine up to 16 modules.
6. The controllers need to be ordered separately, including wired controller, communication line, IOM, temperature sensor. Manufacturer reserves the right to make changes to above specifications without prior notice, please refer to the factory configuration when purchasing.



# CAPACITY CORRECTION FACTOR

## Cooling Capacity Correction Factor

Leaving Water Temperature °C	Ambient Temperature °C																	
	5		10		15		20		25		30		35		40		48	
	Cooling	Power input	Cooling	Power input	Cooling	Power input	Cooling	Power input	Cooling	Power input	Cooling	Power input	Cooling	Power input	Cooling	Power input	Cooling	Power input
5	1.06	0.72	1.08	0.73	1.09	0.71	1.09	0.78	1.04	0.84	0.99	0.90	0.93	0.97	0.87	1.01	0.80	1.08
7	1.14	0.75	1.16	0.76	1.17	0.74	1.16	0.81	1.11	0.87	1.06	0.93	1.00	1.00	0.94	1.04	0.87	1.11
9	1.21	0.78	1.23	0.79	1.24	0.77	1.23	0.84	1.18	0.90	1.13	0.96	1.07	1.03	1.01	1.07	0.94	1.14
12	1.28	0.81	1.30	0.82	1.31	0.80	1.30	0.87	1.25	0.93	1.20	0.99	1.14	1.06	1.08	1.10	1.01	1.17
15	1.35	0.84	1.37	0.85	1.38	0.83	1.37	0.90	1.32	0.96	1.27	1.02	1.21	1.09	1.15	1.13	1.08	1.20

★ Note: Above Correction Factor adapt to 30RHM201/301/401XH, 30RHM201HHE, 30RHM201XHR.



# ELECTRICAL WIRING DIAGRAM

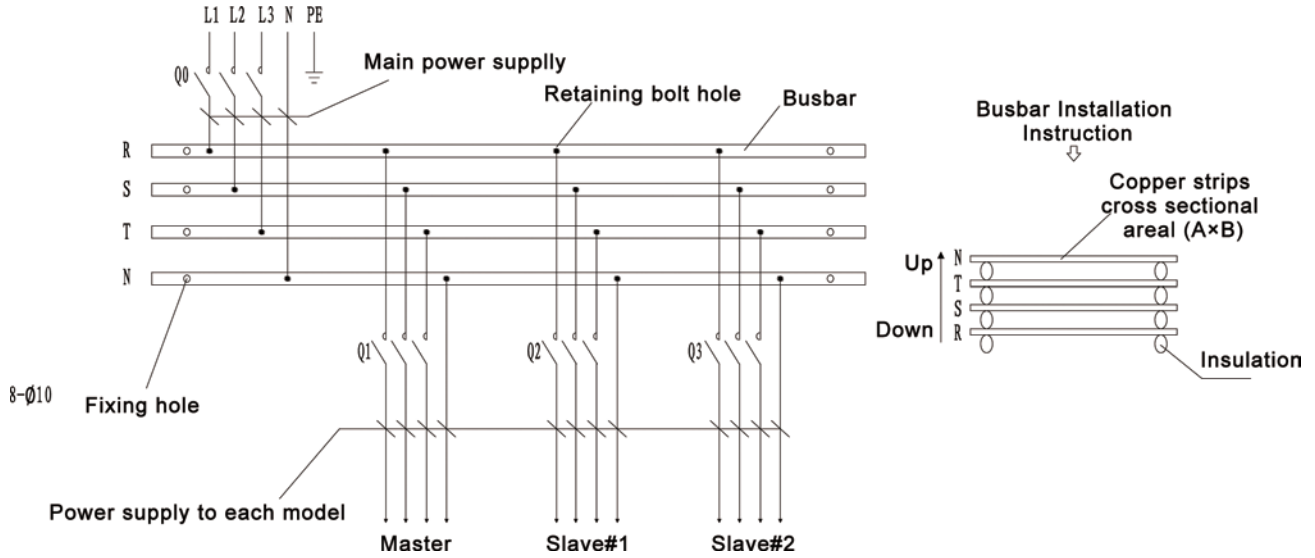

Example lifting schematic for 30RHM203

Model	The maximum operating current	Main power supply wiring			Communication line	Copper specifications
	(A)	Phase line	Neutral line	Ground wire	(RVVP)	(A×B)
30RAM201	50	16	10	16	Communication line between Unit and remote controller is four-Cords telephone wire, factory standard configuration 30 meters. Communication line between different units is 2-cords telephone wire, the factory standard configuration 5 m.	Copper bar cross-sectional area A×B shall not be less than square number of Main power supply wire.
30RAM401	100	50	25	25		

## ★ Notes:

1. The power supply is 380-415V/3N ~ /50Hz.
2. Q0 and Q1/Q2/Q3 is the circuit breaker. For circuit breaker, select D type.
3. Either Q0 and (Q1/Q2/Q3) can be chosen. Q1 /Q2/Q3 is more convenient for single unit maintenance.
4. During on-site installation, circuit breaker I wire I copper need to be selected according to reality, considering water pump and other load.
5. For installation of copper bar, see electric wiring diagram.
6. Copper bar isn't needed for less than two modules.
7. Terminal port is reserved in the factory, customers need to connect on job site.
8. The unit power supply wiring need to be provided by the user, the main power supply wiring must conform to the national standard of electric and electric construction.
9. The recommended power wire specifications is 70 °C PVC insulated cables in the insulation of the cable laid in the insulation wall, the ambient temperature is (30 °C in the air, 20 °C underground) when the selection of copper core cable specifications Take the IEC\_60364-5-523 wire and cable ampacity standard), if the actual installation conditions changes, please refer to service manual according to the manufacturer's specifications, wire and wire laying conditions.
10. The selection of the power wire is closely related with local climate, soil characteristics, cable laying length. Such unit projects are usually designed by the design institute and subjected to design institute.
11. Communication wire must use STP, prohibited to be mixed with strong electricity.

## UNIT INSTALLATION

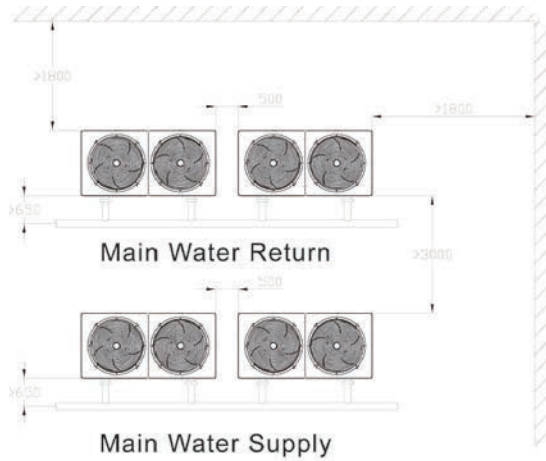

Top view

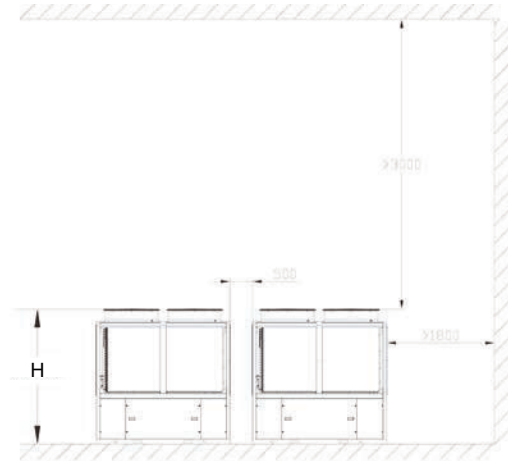

Side view

### ★ Remark:

- 1, 80 cold tons of the following units of water mains recommended with DN80, recommended to install for the same way;
- 80, 160 ~ 2 tons of cold water outlet pipe is recommended to use DN125, it is recommended to install for the same process;
- 160, 240 ~ 3 tons of cold water outlet pipe is recommended to use DN150, it is recommended to install for the same process;
- 240, 500 ~ 4 tons of cold water outlet pipe is recommended to use DN200, it is recommended to install for the same process;
- 5, unit water inlet and outlet connecting pipe: unit take over size reference parameter list, the total water pipe is installed according to the actual pipe.

## UNIT HOISTING

Example lifting schematic for 30RAM20 1

- Keep the package well from the factory to the job site;
- Be careful when carrying the units to ensure the body vertical.
- When lifting the unit, avoid it from hitting other objects to avoid sliding. At the same time the staff should avoid standing below or near the bottom of the unit to ensure safety;
- In order to prevent scratches or deformation of appearance, cable section shall be placed in contact with the unit's protective pads, while support should be added between the ropes to prevent damage machinery by ropes.
- See the parameter table for the reference weight of the hoisting steel pipe, steel rope and lifting locomotive.

The hoisting steel pipe, steel rope and lifting locomotive reference weight see unit parameter table. Protect the inlet and outlet water pipe of the unit to avoid collision during the hoisting process.

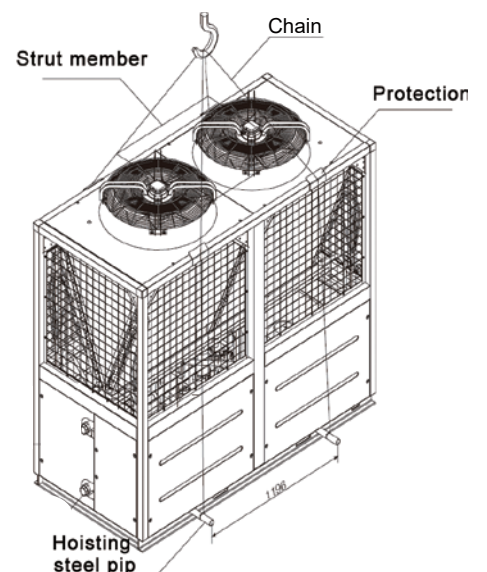

# WATER SYSTEM INSTALLATION

## Water system components

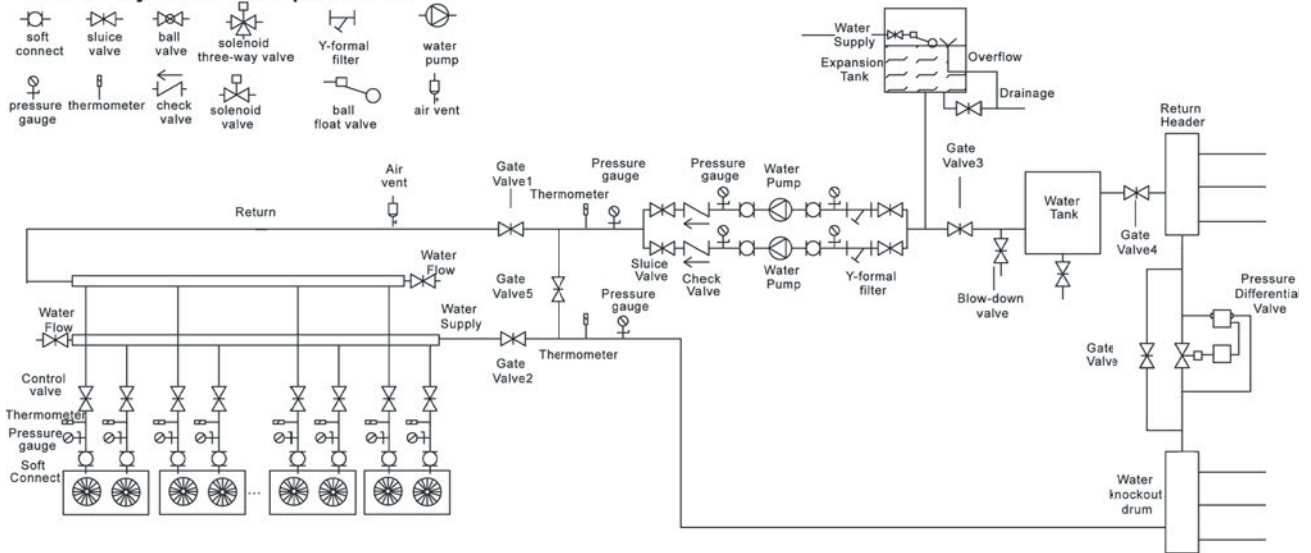

Notice:

- On-site installation of water switches is not required since they have been installed in the units.
- Multi-system water lines are applied to large projects and generally designed to realize area-based water supply. If some areas are being overhauled or closed, the loads may change significantly, so any unit can be turned off for the purpose of energy conservation.
- After the water system of the unit is installed, close the service valves 1 and 2 and open the service valve 5; start the water pump; then wash the water filter; after the water line system is clean, connect the water pipe to the main machine to be ready for normal operation.
- Water pumps shall be selected according to the water flow and required pump head and can be installed on the inlet and outlet header pipes. When the inlet pressure exceeds 1.0 MPa, they are recommended to be installed on the outlet pipe. The pump control shall be interlocked with the unit.
- The automatic differential pressure regulator can facilitate more stable operation of the whole system. Water distributors and collectors realize more reasonable water distribution in all branches.
- For shell and tube module units, it is only required to install Y-shaped water filters on inlet header pipes of units (16 ~ 20 meshes/inch recommended). Such filters shall be washed after commissioning.
- Each inlet branch pipe of units shall be equipped with a water regulating valve to allow water to flow into units at a consistent rate.
- Auxiliary thermal sources like auxiliary electrical heaters, if any, shall be installed on the outlet header pipes of units.
- To ensure balanced water resistance, units shall be subject to equal-length installation.
- The valves 1, 2, 3 and 4 shall be used as service valves while the valve 5 shall be used when the pipes shall be cleaned for initial system commissioning or when the terminals and pipes are subject to water treatment. In such cases, the valves 1 and 2 shall be closed while the valves 3, 4 and 5 shall be opened and the water pump shall be started.
- The size of inlet and outlet collector pipes of units shall be so designed to allow the water flow rate of less than 1 m/s and shall be greater than that of the water system loop pipes connecting with such collector pipes

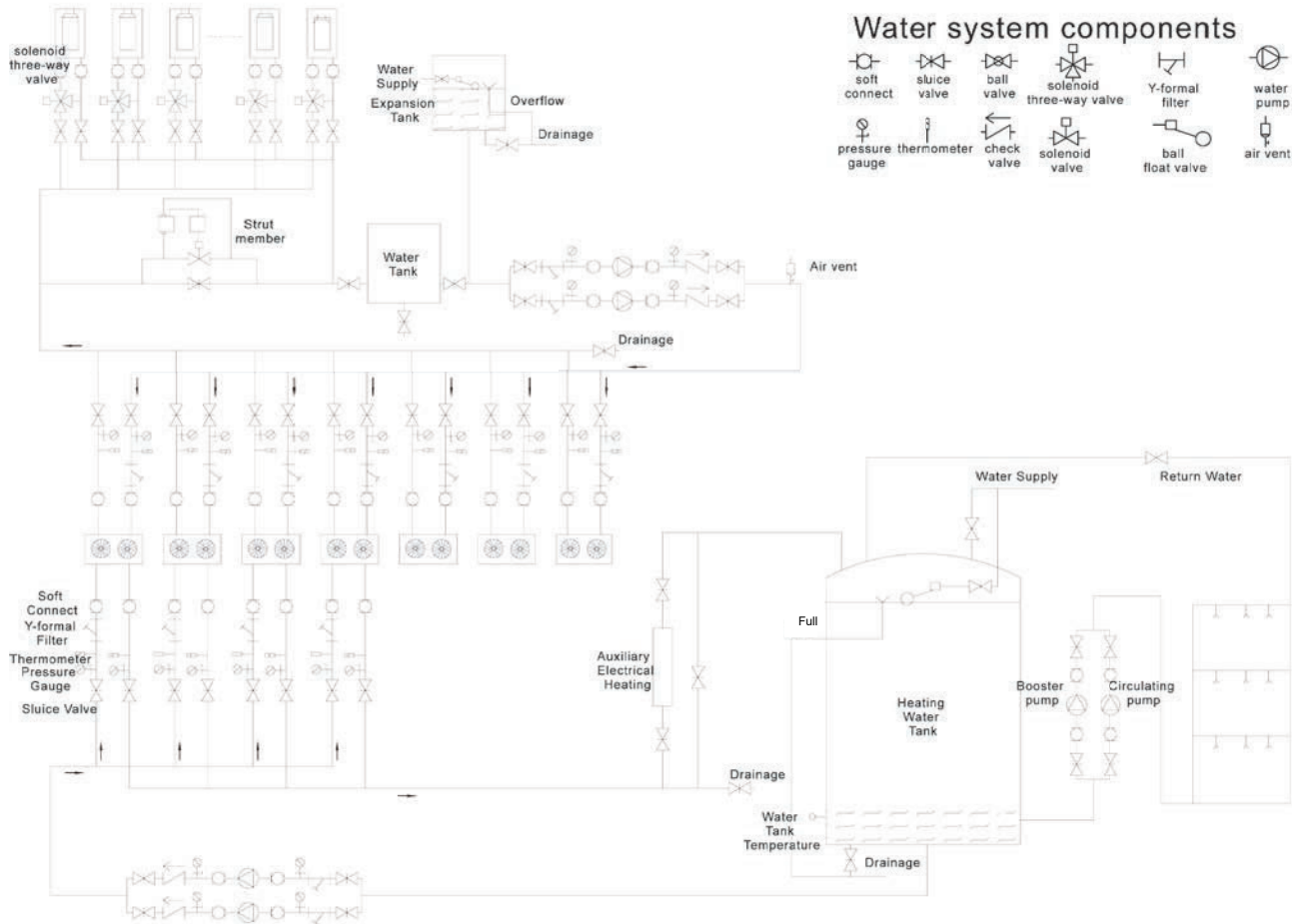

Notes: (installation requirements for domestic hot water system of units)

- To ensure balanced water resistance, the water system shall be subject to equal-length installation in case of parallel connection of several units.
- It is recommended to use externally galvanized internally plastic-lined pipes or stainless steel pipes, instead of PPR pipes, for the hot water system.
- In areas where water harness is great, water treatment devices shall be provided on the water-refilling end.
- The hot water circulating pump shall be installed at the same level with the hot water tank or at a position lower than the lowest level of the water tank.
- The A/C circulating water pump and hot water circulating pump shall be interlocked with the main machine and kept energized.
- The domestic hot water tank shall be checked frequently for its normal water supply capacity.
- All hot water pipes are recommended to be provided with rubber insulation materials. The thickness of the insulation layer shall not be less than 20 mm (if other insulation materials are used, their insulation performance shall not be inferior to that of the foresaid materials); for the insulated outdoor hot water pipes, the insulated materials shall be provided with a protective layer made of galvanized sheet iron or aluminum.
- It is recommended to install the water tank near the hot pump unit as far as practicable, provided that ventilation surrounding the hot pump unit is not deteriorated, so as to reduce thermal loss of pipes.
- It is recommended to install auxiliary electric heaters (if any) at a height lower than the water tank.

## PRECAUTIONS FOR USERS

### Installation requirements for water system

- Circulating water shall be softened water.
- The water system shall be provided with safety valves and automatic water-refilling valves.
- The water flow rate shall not be lower than the normal value on the unit nameplate.
- The automatic air bleeding valve shall be provided at the highest point of the water system.
- A proper water drain valve shall be set at the lowest point of the water system.
- The water system pipes shall be provided with expansion water tanks which can adapt to volume changes caused by water temperature changes.
- The water system pipes shall be provided with bypass pipes which can be connected with water lines of the main machine only after the water system is confirmed to be clean.
- The water system shall be clean frequently to prevent impurities from entering the evaporator and damaging the unit.
- The total capacity of the water system shall be 10 L/kW. In case of insufficient capacity, an energy storage water tank of proper size shall be provided so as to prevent water temperature changes and frequent startup and stop of the unit.

### Maintenance

- The unit should be equipped with the special power supply. The supply voltage fluctuates +10%. The automatic air switch should be used. The setting current is 1.5 times of the running current of the unit. The inverse phase protection devices are installed. Never apply the knife switch unit.
- At the time of the first application every season, the unit must be electrified and preheated for 24 hours and start later. If the single cooling unit will stay for a long period of time, the water in the unit and the pipeline must be drained completely. After the heat pump type units stop, the master controller should correspond with the host and the power supply can never be disconnected to avoid the water pipelines or the unit frozen(the controller in accordance with the environment temperature and the temperature of the incoming water and the outgoing water automatically implement the anti-freezing functions. As for details, see the user manual)
- The host switch can not be operated quite often. It can be operate 6 times per hour at most. The electric control cabinet should avoid humidity.
- Keep the unit in good ventilation environment constantly. The air side heat exchanger should be cleaned regularly.
- The water system should be equipped with the expansion tank. The recycling water should be clean and tidy. At the time of operation, a sufficient water flow (as for details, see the nameplate) should be maintained, or the water side heat exchanger would be frozen. And the filter should be cleaned regularly.
- The water system should be equipped with the expansion tank. The recycling water should be cleaned regularly.
- Appoint the specific person to maintain and record.
- 30RHM201/301/401XH can not conduct the refrigeration when the environment temperature is lower than 5°C. In case that it is necessary to conduct the cryogenic refrigeration, please indicate it on the purchase order.



## DAILY MAINTENANCE

Air conditioners are equipment for air conditioning. The users are recommended to record routine operation date of such equipment and provide regular maintenance.

Before initial service, it is required to check if terminal equipment and other components of the water system work normally.

When the equipment is used, the following maintenance system is recommended:

Description of unit maintenance	Standard maintenance interval	
	Quarterly	Semi-annual
1. Check if the power line (from the power distribution cabinet to the unit) is loosened or damaged.		★
2. Check if there is any abnormal noise when the unit is in operation.		●
3. Check if the air-side heat exchanger has to be cleaned (dust on the surface, impurities, etc.).	●	
4. Clean the filter screens of water filters inside and outside the unit and immediately replace damaged filter screens.	★	●

Note: If necessary, the maintenance system before the equipment is put into service can apply. See Installation Instructions for each model.

### ★ Note:

- Maintenance to be implemented by users: Mandatory inspection items ---; r ecommended inspection items--- ★
- Vulnerable parts necessary for maintenance shall be purchased by users from Carrier.
- The maintenance intervals above are suitable for normal operation, and in case of operation in severe conditions, the interval can be adjusted as required.





Carrier improves the world around us; Carrier improves people's lives; our products and services improve building performance; our culture of improvement will not allow us to rest when it comes to the environment.

