



**AQUAFORCE**<sup>®</sup> greenspeed 

**30XAV**

**Variable Speed Air-cooled Screw Chiller**

Nominal cooling capacity: 327~1385KW



## Turn To The Experts

Carrier is a leading global provider of innovative HVAC, refrigeration, fire, security and building automation technologies.

Supported by the iconic Carrier name, the company's portfolio includes industry-leading brands such as Carrier, Kidde, Edwards, LenelS2 and Automated Logic.

Carrier's businesses enable modern life, delivering efficiency, safety, security, comfort, productivity and sustainability across a wide range of residential, commercial and industrial applications.



In 1998, Time magazine named Dr. Carrier one of its 20 most influential builders and titans of the 20<sup>th</sup> century.



# Nomenclature

30XAV0722

A

PT015/254

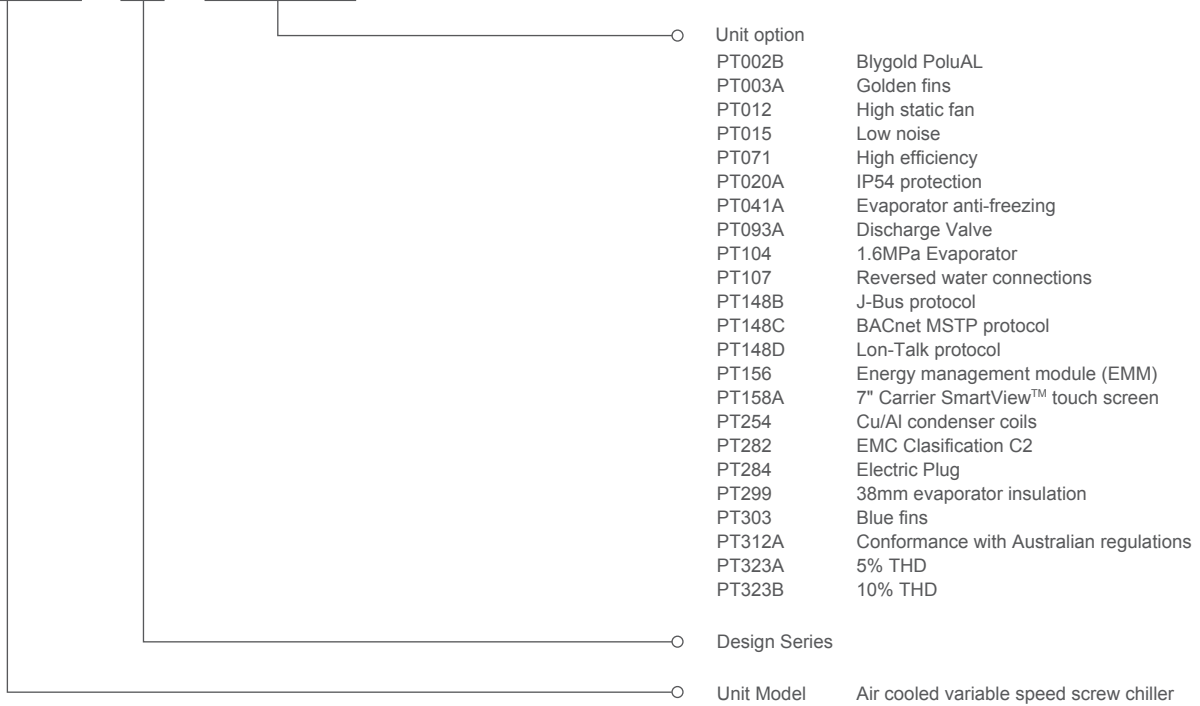

# Operating Range

Evaporator	Min. temperature	Max. temperature
Entering water temperature (at start)	-	45
Entering water temperature (operating)	6.8	21
Leaving water temperature (operating)	3.3	15
Condenser	Min. temperature	Max. temperature
Outdoor air temperature	-20*	46

\* When OAT < 0 C, PT041A is mandatory

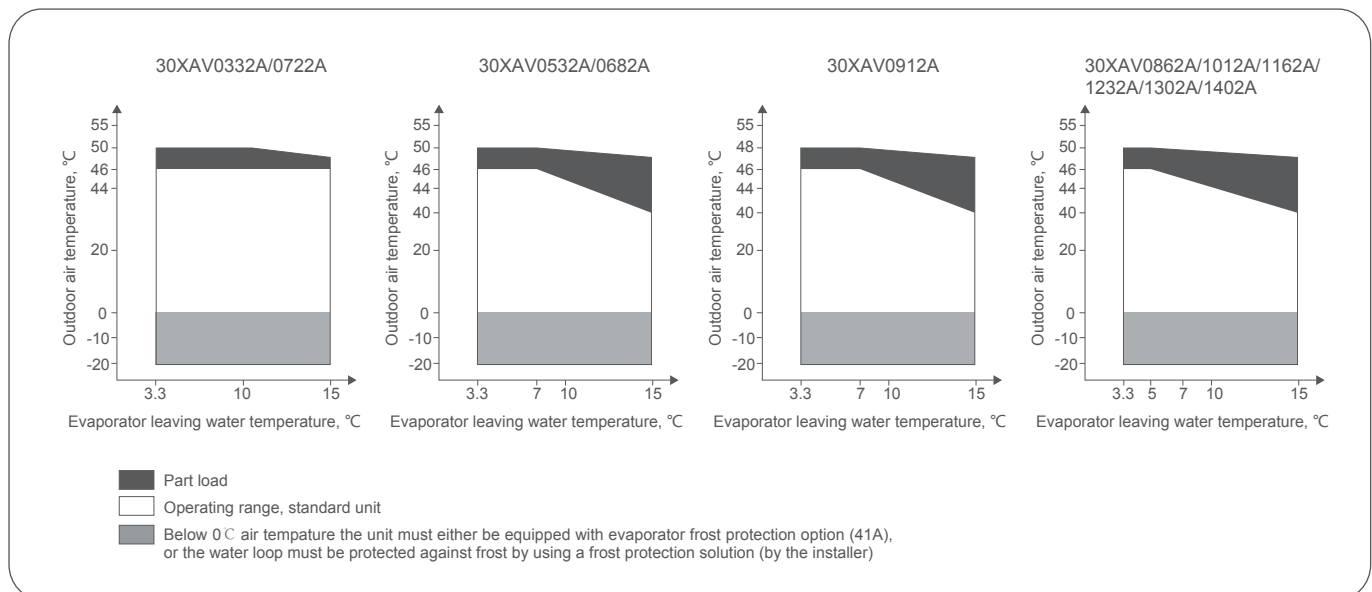



## Introduction

The Aquaforce chillers with Greenspeed® Intelligence are the premium solution for commercial and industrial applications where installers, consultants and building owners require superior reliability and optimal performances, especially at part load.

30XAV are designed to meet current and future requirements in terms of energy efficiency, versatility and operating sound levels. Through the optimised combination of proven best-in-class technologies that include:

- Exclusive screw compressors with Greenspeed® Intelligence - an evolution of the proven traditional Carrier twin-screw compressor design
- The new Carrier SmartView™ control
- Condenser fans with Greenspeed® Intelligence
- Mechanically cleanable flooded evaporator

Furthermore, with 30XAV, Carrier offers its unique expertise and know-how to take care of the machine long after the sale. With the new "CARRIER CONNECT" system in fact, energy and facility managers and end-users in general can rely on the most qualified remote monitoring services.



## Low Energy Consumption

The air conditioning system could use 30%~40% of annual building energy consumption, 30XAV helps customer involved in green building certification with Greenspeed® inverter-driven technology.

- With advanced unit mounted inverter-driven technology, the 30XAV is designed for high performance both at full load and at part load. Exceptional efficiency performance at part load which is up to 5.17, customer even can select PT071 (high efficiency) to achieve high performance and energy saving.
- Cooperating with primary variable flow system, the system efficiency would be further enhanced by synchronized control of chillers and pumps.
- The high energy efficiency is reached thanks to:
  - Inverter driven twin-rotor screw compressors allowing precise capacity matching of building load and reducing unit power input, especially at part-load.
  - Inverter driven fan motors minimizing power consumption while granting optimum air flow.
  - Flooded shell-and-tube evaporator characterized by high efficiency of heat exchange.
  - Electronic expansion device permitting operation at a lower condensing pressure and improved utilization of the evaporator heat exchange surface.
  - Economizer system with electronic expansion device increases cooling capacity by 10% and efficiency by 4%.
- Optimised electrical performance:
  - Negligible start-up current (value is lower than the maximum unit draw)
  - EMC compliancy with Class 3 requirements of the EU standard EN61800-3

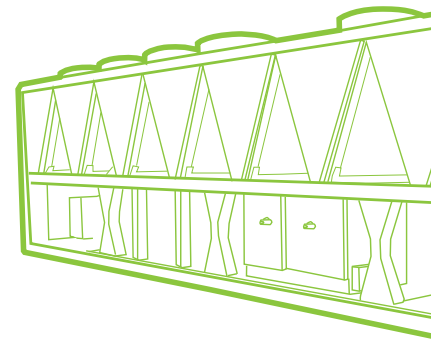
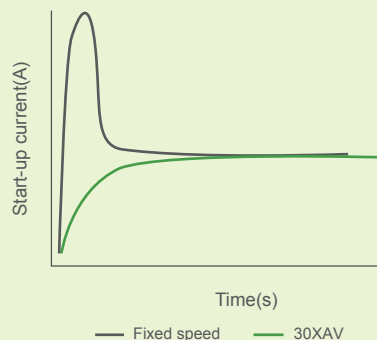
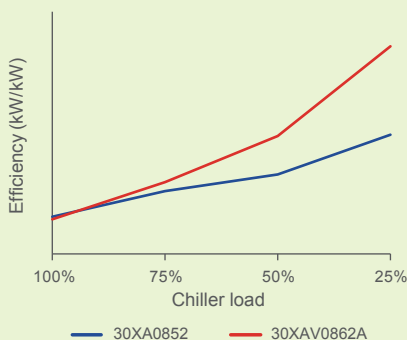

## Environmental care

- HFC-134a refrigerant with zero ozone potential
- Leak tight refrigerant circuits:
  - No capillary tubes and flare connections
  - Verification of pressure transducers and refrigerant charge
  - Discharge line shut-off valve and liquid line (option)



## High Reliability and Easy Service

30XAV offer increased global performance as well as Carrier's acclaimed product quality and reliability.

- ✔ **Screw compressors with Greenspeed® Intelligence:**
  - Industrial-type screw compressors with oversized bearings and motor cooled by suction gas
  - Specifically sized inverter for each compressor motor ensures reliable operation and easy maintenance
  - All compressor components assembly are easily accessible on site minimising down-time
- ✔ **Fans with Greenspeed® Intelligence:**
  - 4th generation of Flying Bird fans equipped with inverter-driven asynchronous motors
  - Specifically sized inverter optimize air flow management reducing cost
  - Easily accessible inverter of fan speed control for easy service
- ✔ **Evaporator:**
  - Carrier designed flooded evaporator with mechanically cleanable water tubes
  - Electronic paddle-free flow switch to ensure prompt alarm in case of poor liquid flow rate
  - Thermal insulation with aluminum sheet finish (option) for perfect resistance to external aggression (mechanical and UV protection)
- ✔ **Two independent refrigerant circuits ensures system redundancy in case one fails\***
- ✔ **Auto-adaptive control:**
  - Control algorithm prevents excessive compressor cycling (Carrier patent)
  - Automatic compressor unloading in case of abnormally high condensing pressure. If condenser coil fouling or fan failure occurs, the Aquaforce continues to operate, but at reduced capacity.
- ✔ **Exceptional endurance tests:**
  - Partnerships with specialised laboratories and use of limit simulation tools (finite element calculation) for the design of critical components
  - Transport simulation test equivalent to 2000 km by truck under harsh conditions
  - Salt mist corrosion resistance test in the laboratory for increased corrosion resistance

\* Available for 30XAV0682A/0862A/1012A/1162A/1232A/1302A/1402A

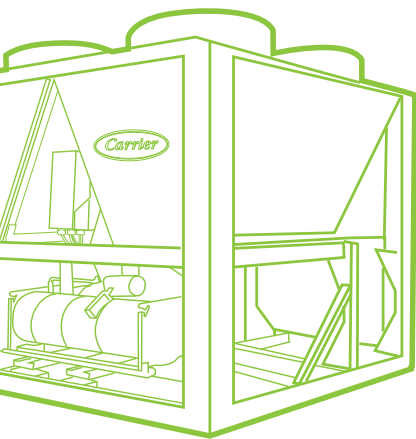

**CERTIFIED®**  
www.ahridirectory.org  
and 551/591

## Minimised Operating Sound Levels

- ✔ The inverter technology used for the compressor and fan motors minimises noise levels at part load operation. When the unit is delivering 25% for example, compressors and fans are running at minimum speed which implies lower noise.
- ✔ **Standard unit features include:**
  - Discharge dampers integrated in the oil separator (Carrier patent)
  - Silencer on the economizer return line
  - Condenser coils in V-shape with an open angle, allowing quieter air flow across the coil
  - Low-noise 4th generation Flying Bird fans, made of a composite material (Carrier patent) which do not generate intrusive low frequency noise.
  - Rigid fan mounting preventing start-up noise (Carrier patent)
- ✔ Multiple options are available to further reduce the global sound level.

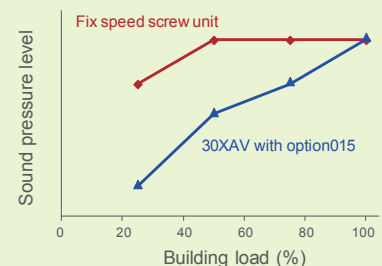

depletion potential

ns are used  
d temperature sensors without transferring  
ne service valve for simplified maintenance

**R134a**

# Technical Insight

## Carrier SmartView™ Control

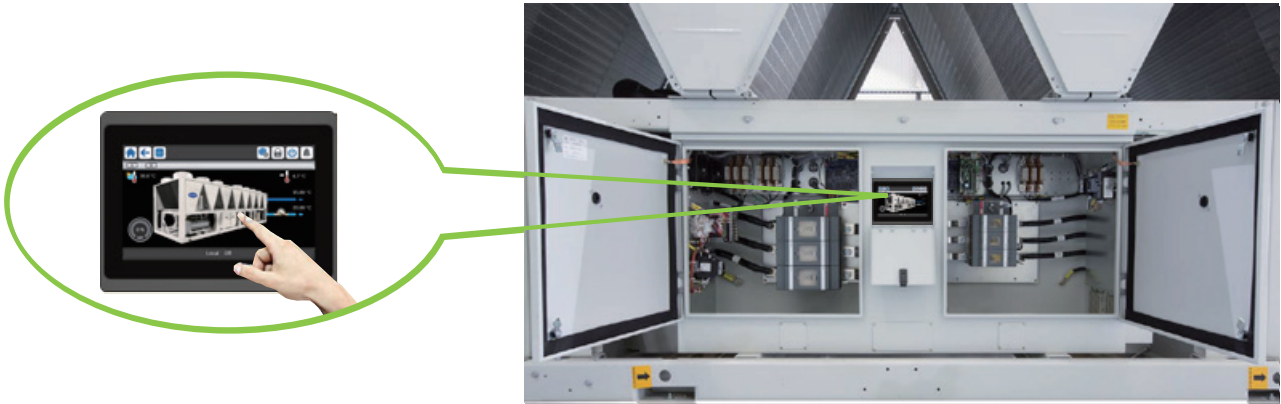

### General Features

- New innovative smart control features:
  - An intuitive and user-friendly, 4.3" colored interface (7" as option)
  - Screen-shots with concise and clear information in local languages
  - Complete menu, customized for different users (end user, service personnel and Carrier-factory technicians)
  - Easy access to the controller box with touch screen mounting to ensure legibility under any lighting conditions
  - Safe operation and unit setting: password protection ensures that unauthorized people cannot modify any advanced parameters
  - Simple and "smart" intelligence uses data collection from the constant monitoring of all machine parameters to optimise unit operation
  - Night-mode: Cooling capacity management for reduced noise level.
- Energy management:
  - Internal time schedule clock controls chiller on/off times and operation at a second set-point
  - The DCT (Data Collection Tool) records the alarms history to simplify and facilitate service operations

### Remote Management (Standard)

- Units with Touch Carrier SmartView™ can be easily accessed from the internet, using a PC with an Ethernet connection. This makes remote control quick and easy and offers significant advantages for service operations.
- Carrier SmartView™ is Standardizedly integrated with BACnet IP, Modbus IP & RTU, and also support Lon Talk, J-Bus, BACnet MSTP via optional communication gateways.
- Aquaforce with Greenspeed® technology is equipped with an RS485 serial port that offers multiple remote control, monitoring and diagnostic possibilities. When networked with other Carrier equipment through the CCN (Carrier Comfort Network - proprietary protocol), all components form a HVAC system fully-integrated and balanced through one of the Carrier's network system products, like the Chiller System Manager or the Plant System Manager (optional). The 30XAV also communicates with other building management systems via optional communication gateways.

- The following commands/visualizations are possible from remote connection:
  - Start/Stop of the machine
  - Dual set-point management: Through a dedicated contact is possible to activate a second set-point (example: unoccupied mode)
  - Demand limit setting: To limit the maximum chiller capacity to a predefined value
  - Water pump control: These outputs control the contactors of one/two evaporator water pumps
  - Operation visualization: Indication if the unit is operating or if it's in stand-by (no cooling load)
  - Alarm visualization

### Remote Management (EMM option)

- The Energy Management Module (EMM) offers extended remote control possibilities:
  - Room temperature: Permits set-point reset based on the building indoor air temperature (if Carrier thermostat are installed)
  - Set-point reset: Ensures reset of the cooling set-point based on a 4-20 mA or 0-10 V signal
  - Demand limit: Permits limitation of the maximum chiller power or current based on 0-10 V signal
  - Demand limit 1 and 2: Closing of these contacts limits the maximum chiller power or current to two predefined values
  - User safety: This contact can be used for any customer safety loop; opening the contact generates a specific alarm
  - Ice storage end: When ice storage has finished, this input permits return to the second set-point (unoccupied mode)
  - Time schedule override: Closing of this contact cancels the time schedule effects
  - Out of service: This signal indicates that the chiller is completely out of service
  - Chiller capacity: This analogue output (0-10 V) gives an immediate indication of the chiller capacity
  - Alert indication: This volt-free contact indicates the necessity to carry out a maintenance operation or the presence of a minor fault
  - Compressors running status : Set of outputs (as many as the compressors number) indicating which compressors are running.

## Technical Insight

Greenspeed® intelligence

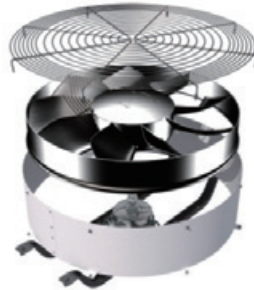
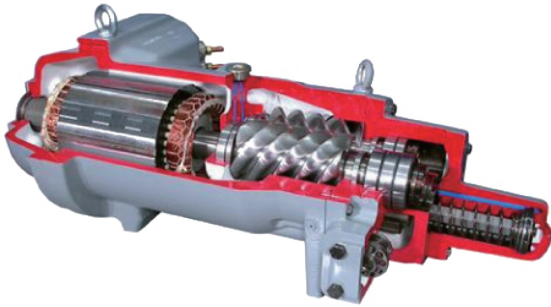

### Inverter-driven screw compressor

The new generation of Carrier inverter-driven screw compressors benefits for Carrier's long experience in the development of twin-rotor screw compressors. The design of the thunderbolt compressors is based on the successful 06T screw compressor, core of the well-known Aquaforce series. Furthermore, it is designed for high performance both at full load and part load (IPLV/NPLV\*).

- Micro-class manufactured screw rotors mesh precisely with high durability. Oversized bearing and motor allow wide cooling capacity range.
- A dedicated oil separator is installed at the discharge of each compressor to ensure maximum oil return: oil separates from refrigerant per gravity and returns to the low pressure side of the compressor without use of additional pumps.
- Advanced control algorithms combine inverter frequency output with motor input logic to minimise mechanical part stress, resulting in best compression performance and high chiller reliability. The compressor is equipped with bearings with oversized rollers, oil pressure lubricated for reliable and durable operation, even at maximum load.
- The silencer in the oil separator line (at the compressor outlet) considerably reduces discharge gas pulsations for much quieter operation.

### Inverter-driven Flying Bird IV fan

- Low-noise 4th generation Flying Bird fans, made of a composite material (Carrier patent) which do not generate intrusive low frequency noise.
- Condenser coils in specially sized V-shape with an open angle, allows quieter air flow across the coil.
- With smart control algorithms, inverter driven fan motors precisely match the building load while granting optimum air flow for minimized energy consumption and reduced noise level.

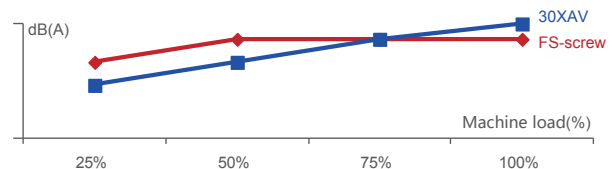

- Night mode: During user defined period, precisely limit the cooling capacity within pre-defined value for lower energy consumption and noise level by reducing inverter frequency of compressors and fan motors.

\*IPLV(Integrated Part-Load Value), a single number of part-load efficiency, it's rated at 100%, 75%, 50%, and 25% load relative to the full-load rating net refrigerating capacity at the standard rating AHRI conditions. Condenser entering air temperature is 35°C, 26.7°C, 18.3°C, 12.8°C respectively. Evaporator LWT is kept constant 7.0°C.  
NPLV(Non-Standard Part-Load Value), a single number of part-load efficiency referenced to conditions other than IPLV conditions. At 100% load, the condenser entering air temperature is user-defined; at 75% and 50% load, condenser entering air temperature is vary linearly from the selected EWT at 100% load to 18.3°C at 33% load, and fixed at 18.3°C for 33% to minimum load. Evaporator LWT at each load is user-defined as well.

## Designed to Support Green Building Design

A green building is a building that is environmentally sustainable and has been designed, constructed and is operated to minimize the total impact on the environment.

The underlying principles of this approach: the resulting building will be economical to operate, offer increased comfort and create a healthier environment for the people who live and work there, increasing productivity.

The air conditioning system can use between 30 and 40% of the annual building energy consumption. Selection of the right air conditioning system is one of the main aspects to consider when designing a green building. For buildings with a variable load throughout the year 30XAV units offer a solution to this important challenge.

A number of green building certification programs exist in the market and offer third-party assessment of green building measures for a wide variety of building types.

The following example looks at how Carrier's new 30XAV range helps customers involved in LEED® building certification.

### 30XAV and LEED® certification.

The LEED® (Leadership in Energy and Environmental Design) green building certification programme is a pre-eminent programme to rate the design, construction and operation of green buildings with points assigned in seven credit categories:

- Sustainable Sites (SS)
- Water Efficiency (WE)
- Energy & Atmosphere (EA)
- Materials & Resources (MR)
- Indoor Environmental Quality (IEQ)
- Innovation in Design (ID)
- Regional Priority (RP)

There are a number of different LEED® products.

Whilst the strategies and categories assessed remain the same, the point distribution varies to address different building types and application needs, for example according to New Construction, Schools, Core & Shell, Retail and Healthcare.

5 All programmes now use the same point scale:

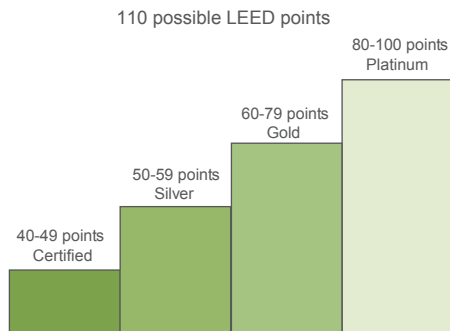

The majority of credits in LEED® rating systems are performance-based and achieving them is dependent on the impacts of each component or sub-system to the overall building.

Whilst the LEED® green building certification programs don't certify products or services, the selection of the right products, systems or service programs is critical to obtaining LEED® certification for a registered project because the right products or service programmes can help meet the goals of green construction and ongoing operation and maintenance.

The choice of heating, ventilating and air conditioning (HVAC) products in particular can have a significant impact on LEED® certification, as the HVAC system directly impacts two categories that together influence 40% of the available points.

Overview of LEED for new construction and major renovations

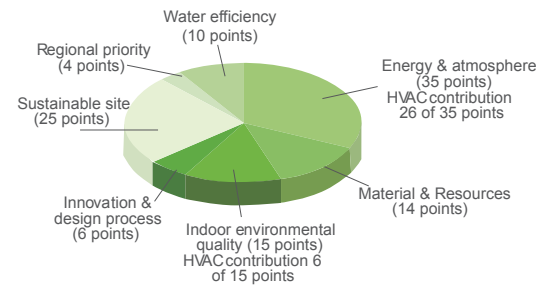

The new 30XAV units from Carrier can assist building owners to earn LEED® points in particular in the Energy & Atmosphere (EA) credit category and help address the following prerequisites and credit requirements:

- EA prerequisite 2: Minimum energy Performance

The 30XAV exceeds the energy efficiency requirements of ASHRAE 90,1-2007; therefore it complies with the prerequisite standard.
- EA prerequisite 3: Fundamental Refrigerant Management

The 30XAV does not use chlorofluorocarbon (CFC) refrigerants thus satisfying the prerequisite statement.
- EA credit 1: Optimise energy performance (1 to 19 points)

Points for this credit are assigned depending the energy cost reduction virtually achievable by the new building, compared to ASHRAE 90,1-2007 reference. The 30XAV, which is designed for high performance especially during part load operation, contributes reducing the energy consumption of the building and therefore helps gaining points within this credit. In addition, the Carrier HAP (Hourly Analyses Program) can be used as an energy analyses program complying with the modeling requirements for this credit and produce reports that are easily transferable to LEED® templates.
- EA credit 4: Enhanced refrigerant management (2 points)

With this credit, LEED® awards systems that minimize the Ozone Depletion Potential (ODP) and Global Warming Potential (GWP) of the system. The 30XAV uses a reduced R134a charge and therefore contributes toward satisfying this credit under LEED®.

NOTE: This section describes the prerequisites and credit requirement in LEED® for New Construction and is directly related to the 30XAV. Other prerequisites and credit requirements are not directly and purely related to the air-conditioning unit itself, but more to the control of the complete HVAC system.

i-Vu®, Carrier's open control system, has features that can be valuable for:

- EA prerequisite 1: Fundamental commissioning of energy management system
- EA credit 3: Enhanced commissioning (2 points)
- EA credit 5: Measurements and verification (3 points)

NOTE: Products are not reviewed or certified under LEED®. LEED® credit requirements cover the performance of materials in aggregate, not the performance of individual products or brands. For more information on LEED®, visit [www.usgbc.org](http://www.usgbc.org).



## Technical Specification

Model	30XAV	0332A	0532A	0682A	0722A	0862A	0912A	1012A	1162A	1232A	1302A	1402A
Nominal cooling capacity*	kW	327.0	528.0	679.0	722.0	864.0	895.0	1015.0	1147.0	1232.0	1294.0	1385.0
Compressor power input	kW	99.8	161.2	207.3	226.4	270.5	276.6	322.5	359.3	390.1	411.3	439.0
Nominal COP	kW/kW	3.006	3.052	3.060	2.961	3.001	3.030	2.962	3.000	2.962	2.960	2.962
IPLV.IP**	kW/kW	5.062	5.088	5.112	5.036	5.166	5.051	5.012	5.060	5.080	5.063	5.029
Compressor		VFD Semi-hermetic screw compressor										
CircuitA		1	1	1	1	1	1	1	1	1	1	1
CircuitB		-	-	1	-	1	-	1	1	1	1	1
Minimum capacity	%	15%	15%	7%	15%	7%	15%	7%	7%	7%	7%	7%
Refrigerant		R134a										
CircuitA	kg	105	125	100	210	123	245	130	178	200	200	200
CircuitB	kg	-	-	102	-	97	-	120	173	125	125	200
Control		Carrier SmartView™ system										
Condenser		Cu/Al heat exchanger										
Fans		IV generation FlyingBird axial fan										
Quantity		6	8	10	12	12	13	14	16	18	18	20
Total air flow	l/s	27084	36112	45140	54168	54168	58682	63196	72224	81252	81252	90280
Fan speed	rpm	950										
Evaporator		Flooded multi-pipe										
Water content	l	54	77	94	98	130	130	140	158	168	186	186
Nominal water flow	l/s	15.59	25.17	32.36	34.42	41.19	42.66	48.38	54.68	58.73	61.68	66.02
Nominal water pressure drop	kPa	32.0	51.0	45.5	49.1	42.6	41.0	39.1	43.3	26.2	37.5	51.1
Max. water-side pressure (without hydronic module)	kPa	1000										
Water connection		Victaulic										
Nominal Diameter	DN	125	125	150	150	150	150	200	200	200	200	200
Electrical data												
Nominal power supply		400V-3Ph-50Hz										
Control power supply		VFD start										
Start-up method		24V via internal transformer										
Fan and control power	kW	9.0	11.8	14.6	17.4	17.4	18.8	20.2	23.0	25.8	25.8	28.6
Nominal unit current draw, Circuit A+B	A	173	275	352	387	457	468	548	607	660	697	727
Maximum unit current draw, Circuit A+B	A	213	329	421	469	531	545	650	742	791	791	924
Maximum start-up current, Circuit A+B	A	213	329	421	469	531	545	650	742	791	791	924
Max operation power, Circuit A+B	kW	136	210	268	299	338	347	414	473	504	504	589
Unit length	mm	3604	4798	5992	7186	7186	8380	8380	9574	10768	10768	11962
Unit width	mm	2253										
Unit height	mm	2297										
Unit weight	kg	3214	4749	5590	5936	6557	6584	7606	8311	9614	9666	10617
Operating weight (Standard)	kg	3268	4826	5684	6036	6687	6714	7746	8469	9782	9852	10803

### Notes:

\* Nominal conditions - evaporator entering/leaving water temperature 12/7°C, outdoor air temperature 35°C  
Evaporator fouling factor 0.018m<sup>2</sup>K/kW

\*\* IPLV calculations according to standard performances (in accordance with AHRI 550-590)

## Option & Accessories

Options	No.	Description	Advantage	Model
Blygold PoluAL	002B	Coil with factory-applied Blygold PoluAL treatment	Improved corrosion resistance, recommended for heavy marine and industrial environments	30XAV0332~1402A
Gold Fin	003A	Fin made of pre-treated aluminium (polyurethane and epoxy)	Improved corrosion resistance, recommended for light marine environments	30XAV0332~1402A
High static fan	012	High static fan (60Hz)	Available for ducted condenser air discharge optimized condensing temperature control	30XAV0332~1402A
Low noise (Compressor sound enclosure)	015	Compressor sound enclosure	Low operating noise	30XAV0332~1402A
IP54	020A	IP54 electrical box protection	Increased leak tightness of control boxes	30XAV0332~1402A
Evaporator anti-freeze	041A	Electric heater on evaporator	Ensures evaporator anti-freeze protection down to -20° C without glycol	30XAV0332~1402A
Discharge valve	093A	Discharge valve	Easy for service	30XAV0332~1402A
1.6Mpa evaporator	104	Reinforced evaporator for extension of the maximum water-side pressure range to 1.6Mpa	Covers applications with a high water column (high buildings)	30XAV0332~1402A
Reversed water connections	107	Evaporator with reversed water inlet/outlet	Simplification of water piping	30XAV0332~0722A
J-Bus gateway	148B	Two-directional communication board with J-Bus protocol	Easy connection by communication bus to building management system	30XAV0332~1402A
LonTalk gateway	148D	Two-directional communication board with LonTalk protocol	Easy connection by communication bus to building management system	30XAV0332~1402A

Options	No.	Description	Advantage	Model
BACnet MSTP protocol	148C	Two-directional communication board with BACnet MSTP protocol	Easy connection by communication bus to building management system	30XAV0332~1402A
Energy Management Module (EMM)	156	Energy Management Module (EMM)	For economical operation and easy management	30XAV0332~1402A
7" Carrier SmartView™ screen	158A	7" Carrier SmartView™ screen	Better operation experience	30XAV0332~1402A
Cu/Al condenser coils	254	Coil made of copper tube with aluminium fin	-	30XAV0332~1402A
EMC Classification C2	282	EMC Classification C2	For models Frame C2 90kW the additional outdoor kit will not be applied; as these drive in the format C2 are already IP55 rated; they will not have the fuses included	30XAV0332~1402A
Electric Plug	284	Electric Plug	-	30XAV0332~1402A
38mm cooler insulation	299	38mm cooler insulation	Better prevents condensation on high humidity environment	30XAV0332~1402A
Blue fin	303	Hydrophilic aluminium foil	Enhanced hydrophilic character and better aesthetics	30XAV0332~1402A
Conformance with Australian regulations	312A	Evaporator and oil separator modified according to Australian regulations	Conformance with Australian regulations	30XAV0332~1402A
5% THD	323A	Mitigate the harmonics by using harmonic filter (free standing/ outdoor) as the power supply to the unit	Mitigate the harmonics of unit to 5% THDI	30XAV0332~1402A
10% THD	323B	Mitigate the harmonics by using harmonic filter (free standing/ outdoor) as the power supply to the unit	Mitigate the harmonics of unit to 10% THDI	30XAV0332~1402A

# Dimension&Clearances

30XAV0332A/0532A

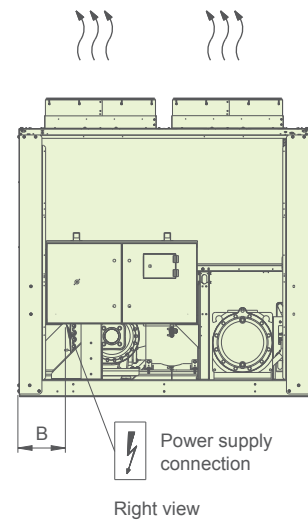
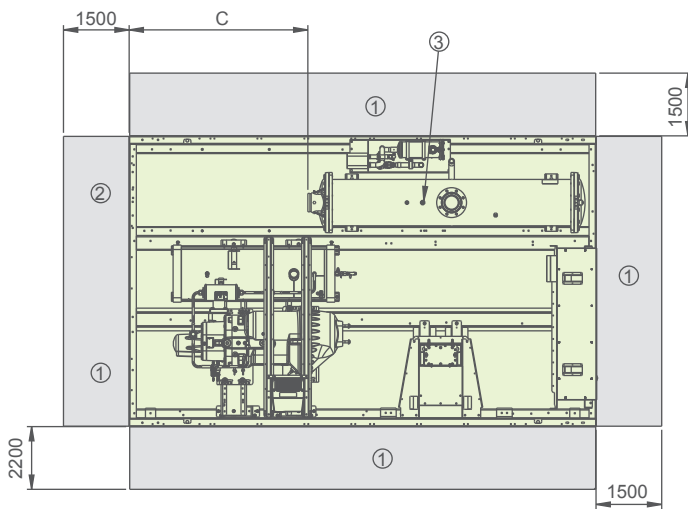
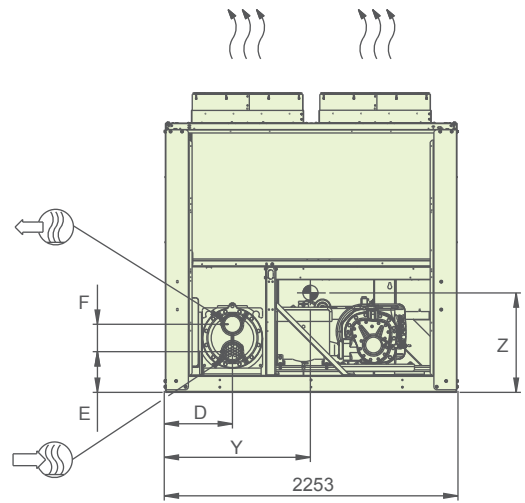
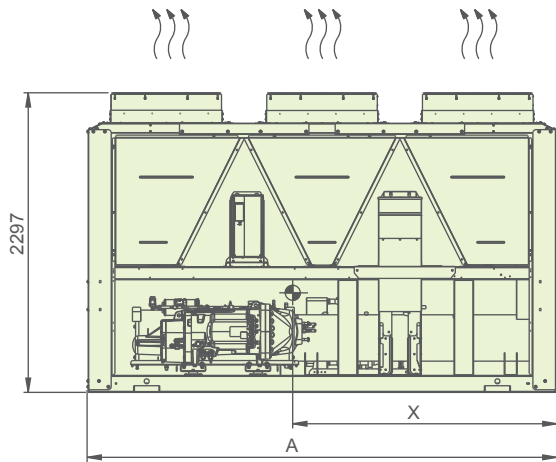

- ① Required clearances for maintenance
- ② Recommended space for evaporator tube removal
- ③ Safety valve
- Water inlet

- Water outlet
- Air outlet
- Power supply connection
- Center gravity

30XAV	A	B	C	D	E	F	X	Y	Z
0332A	3604	366	1371	523	312	210	2021	1101	759
0532A	4798	801	2186	480	357	272	2624	1226	940

Note:Single power connection point, and arrive from the bottom. Above dimension drawing based on 30XAV0332A outline.



# Dimension&Clearances

30XAV0682A/0862A

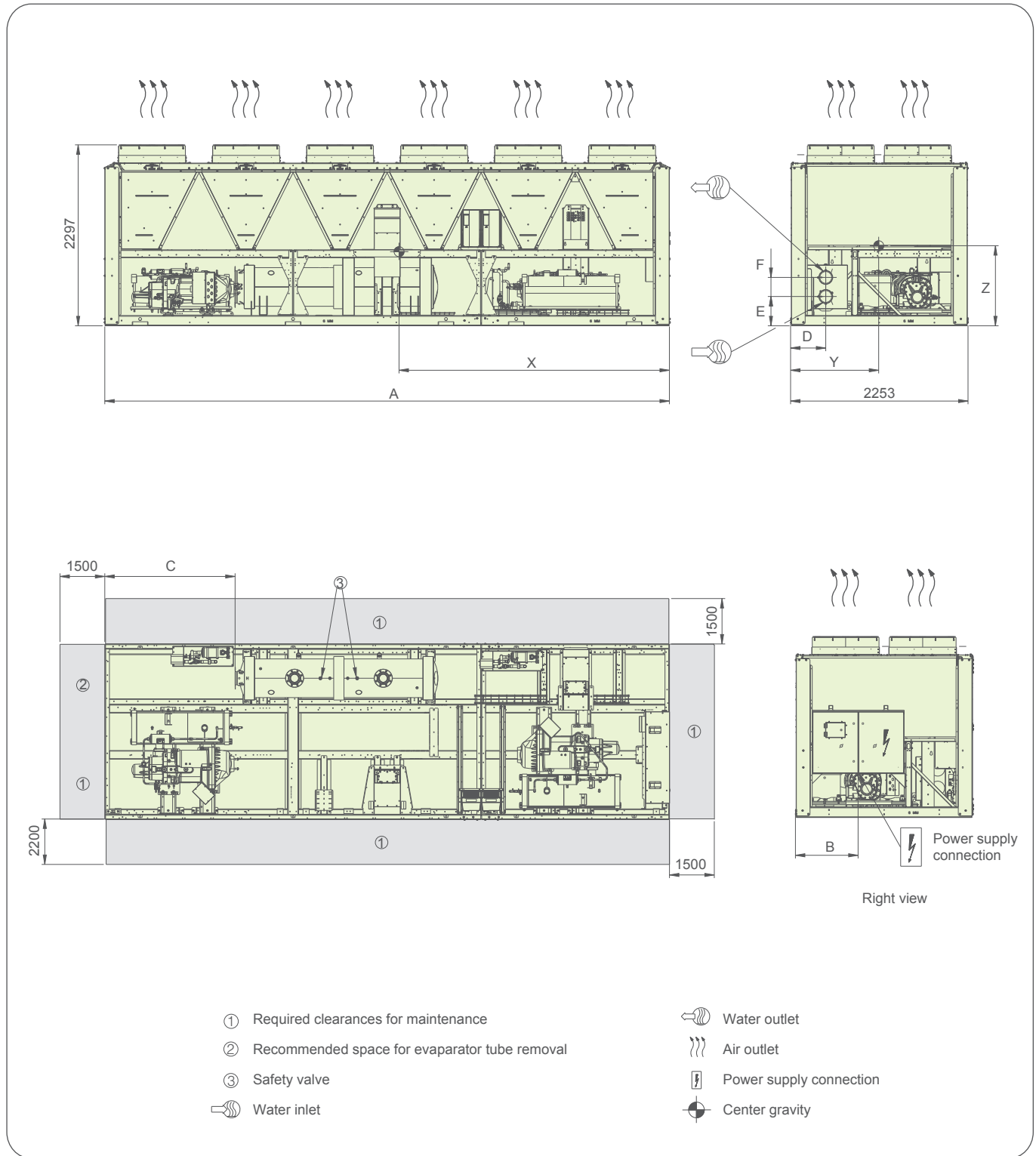

30XAV	A	B	C	D	E	F	X	Y	Z
0682A	5992	830	1652	447	372	242	3027	1136	907
0862A	7186	800	1647	447	325	284	3474	1193	786

Note:Single power connection point, and arrive from the bottom.Above dimension drawing based on 30XAV0862A outline.

# Dimension&Clearances

30XAV0722A/0912A

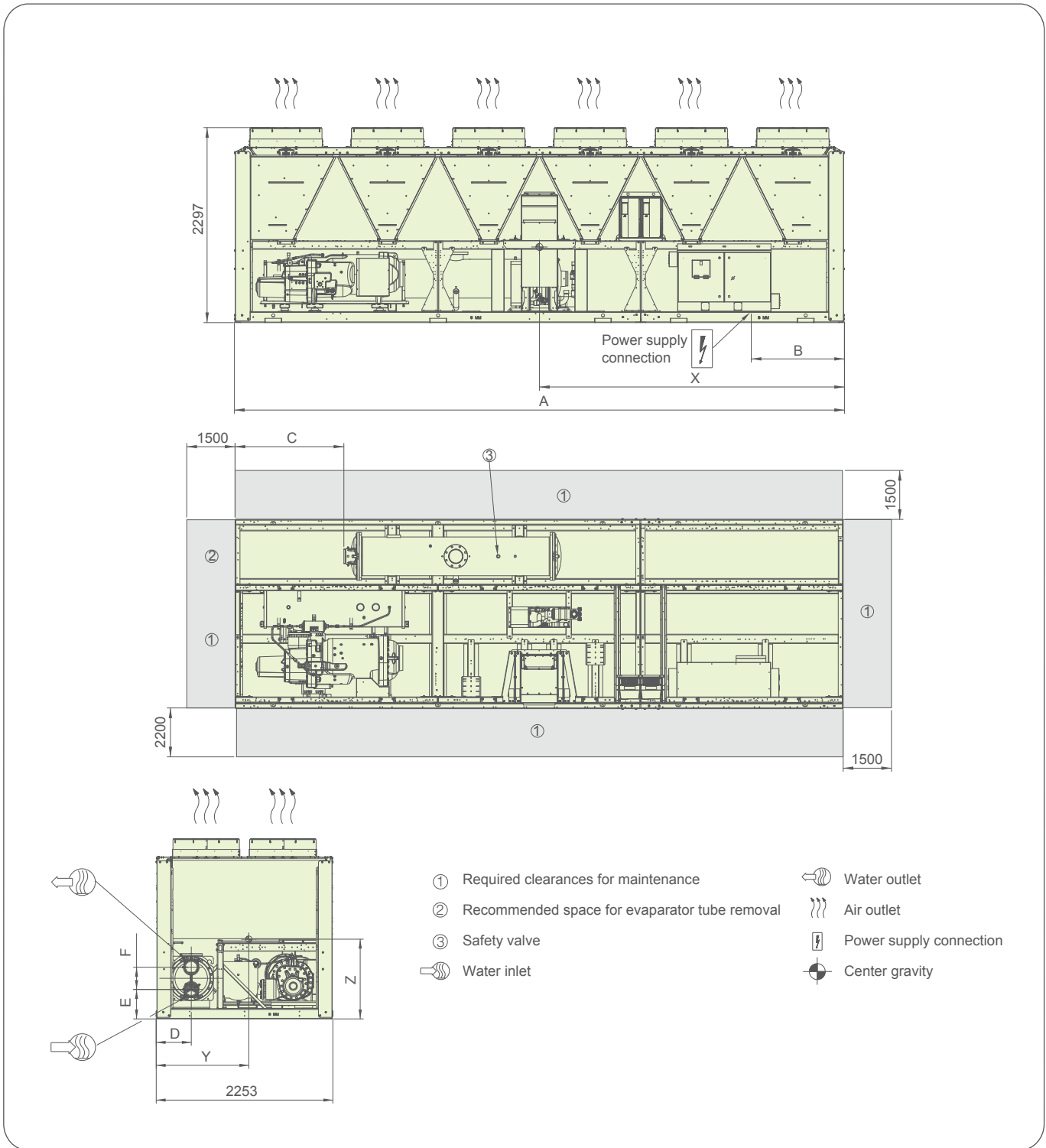

30XAV	A	B	C	D	E	F	X	Y	Z
0722A	7186	1098	1285	447	376	284	4272	1194	900
0912A	8380	1416	2474	447	375	284	4623	1155	939

Note: Single power connection point, and arrive from the bottom. Reserve 120mm height space below the unit for power supply connection (unit aerial installation or cable slot arrangement in unit base). Above dimension drawing based on 30XAV0722A outline.

## Dimension&Clearances

30XAV1012A/1162A

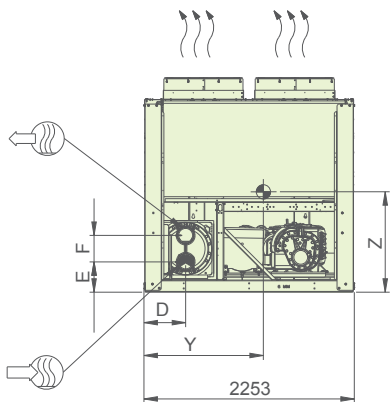
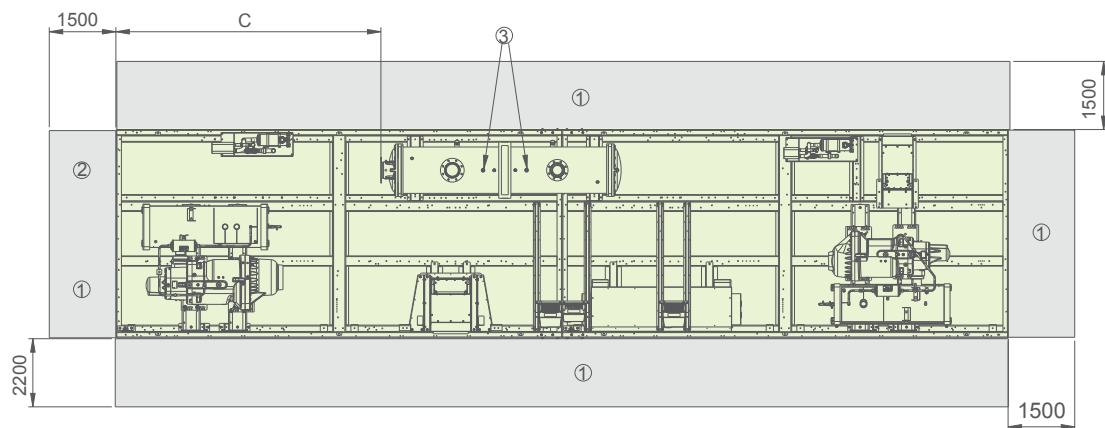
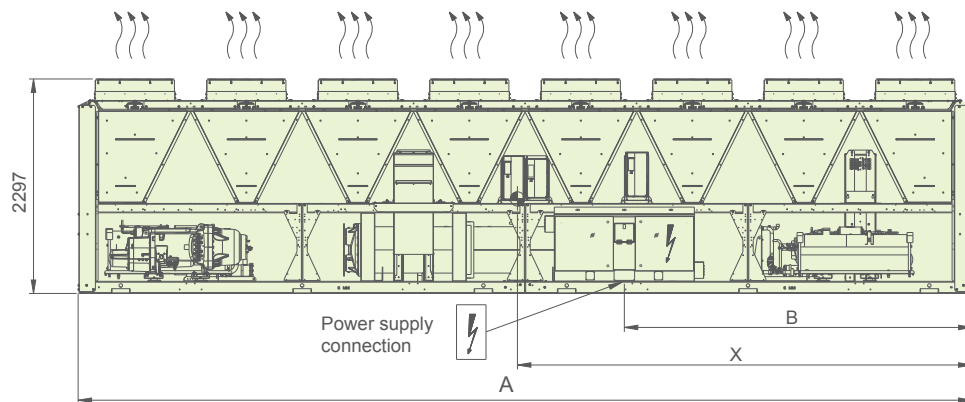

- ① Required clearances for maintenance
- ② Recommended space for evaporator tube removal
- ③ Safety valve
- Water inlet
- Water outlet
- Air outlet
- Power supply connection
- Center gravity

30XAV	A	B	C	D	E	F	X	Y	Z
1012A	8380	3477	1711	483	297	290	4487	978	771
1162A	9574	3585	2804	447	296	290	4843	1207	890

Note: Single power connection point, and arrive from the bottom. Reserve 120mm height space below the unit for power supply connection (unit aerial installation or cable slot arrangement in unit base). Above dimension drawing based on 30XAV1162A outline.

# Dimensions/Clearances

30XAV1232A/1302A/1402A

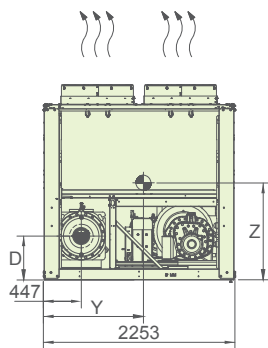
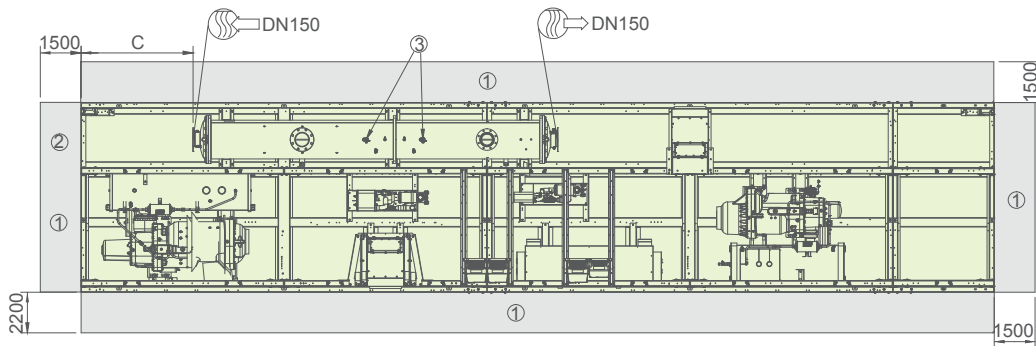
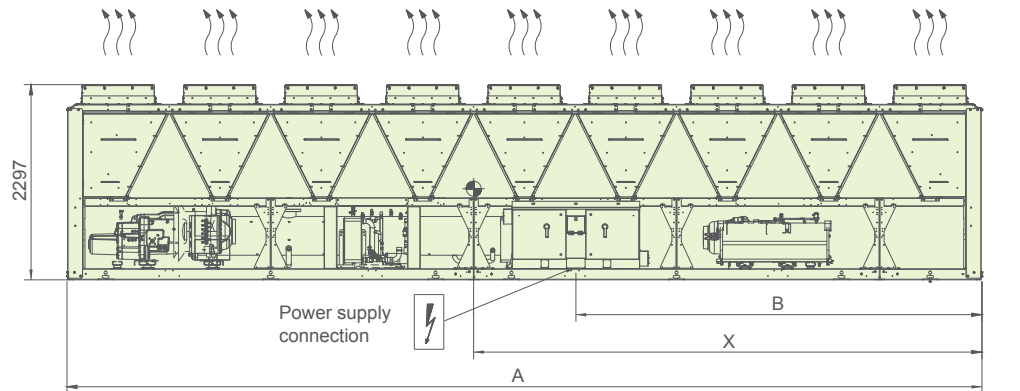

- ① Required clearances for maintenance
- ② Recommended space for evaporator tube removal
- ③ Safety valve
- Water inlet
- Water outlet
- Air outlet
- Power supply connection
- Center gravity

30XAV	A	B	C	D	X	Y	Z
1232A	10768	4778	1318	517	5893	1150	936
1302A	10768	4778	1318	517	5885	1146	934
1402A	11962	5973	1318	517	6603	1223	934

Note: Single power connection point, and arrive from the bottom. Reserve 120mm height space below the unit for power supply connection (unit aerial installation or cable slot arrangement in unit base). Above dimension drawing based on 30XAV1232A outline.



## Multiple Chiller Installation

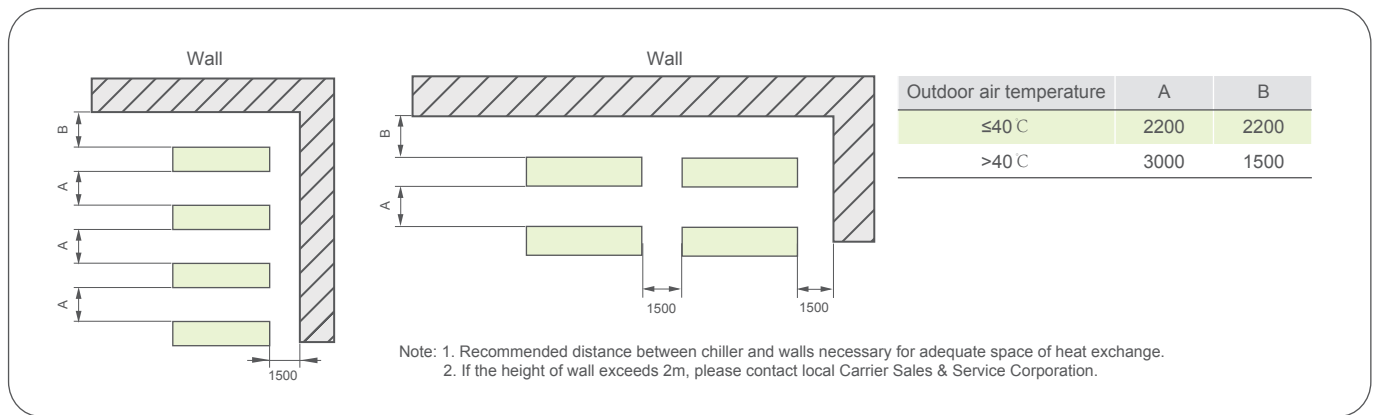

## Field Control Wiring

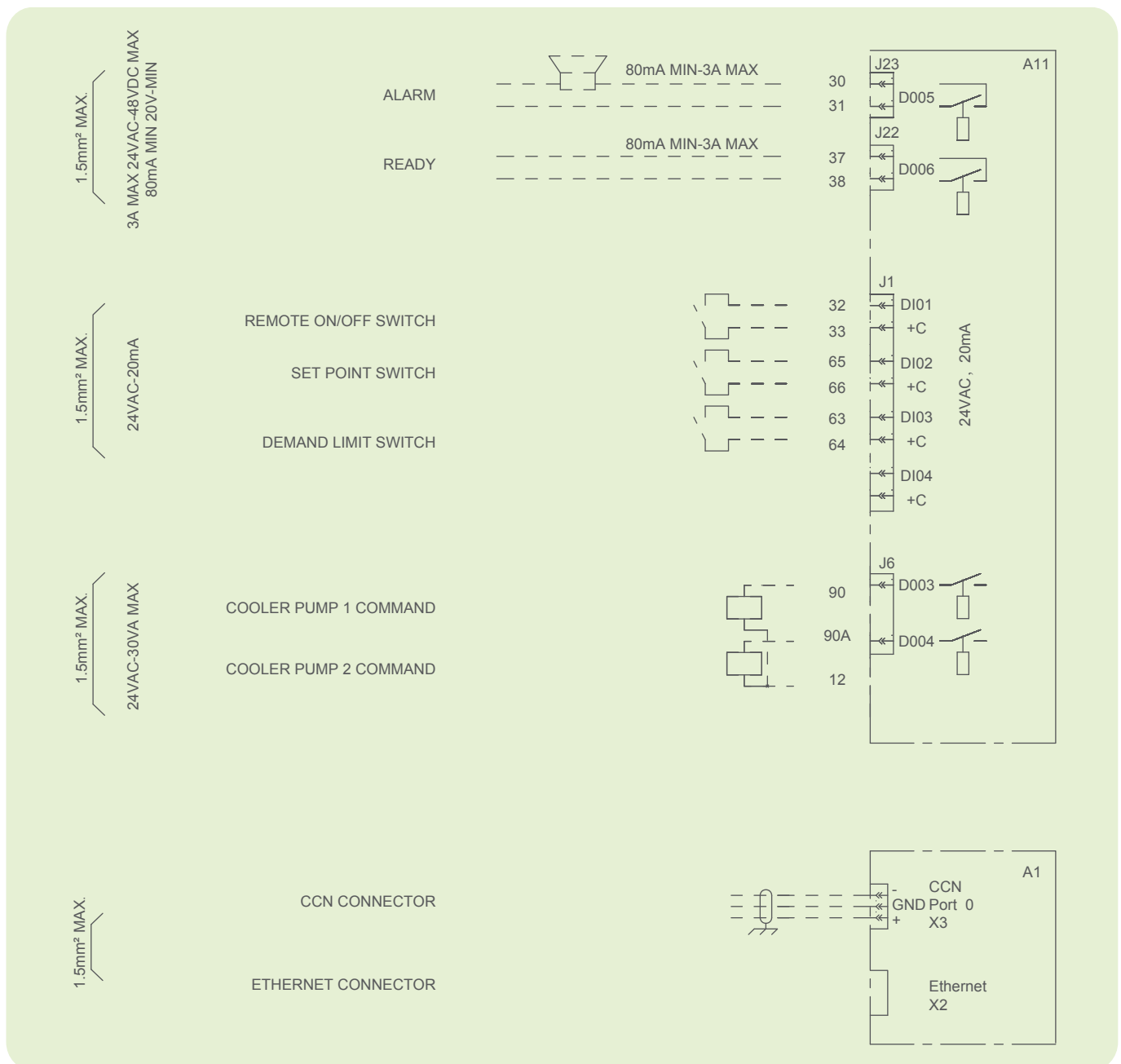

# Water Pressure Drop

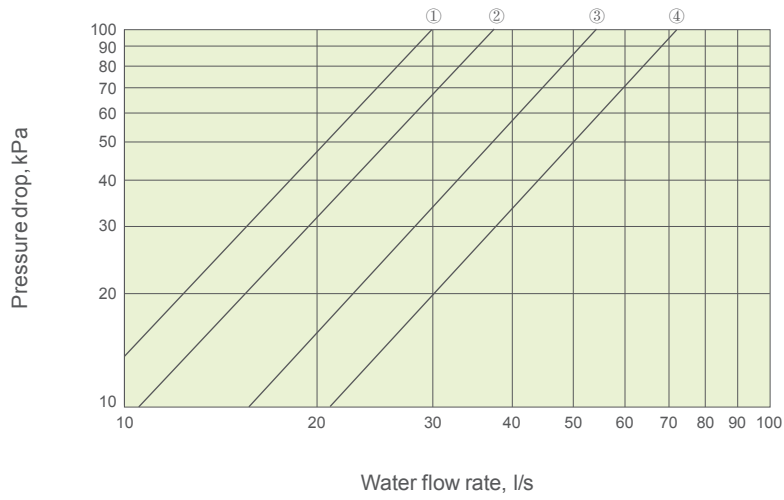

- ① 30XAV0332A
- ② 30XAV0532A
- ③ 30XAV0722A
- ④ 30XAV0912A

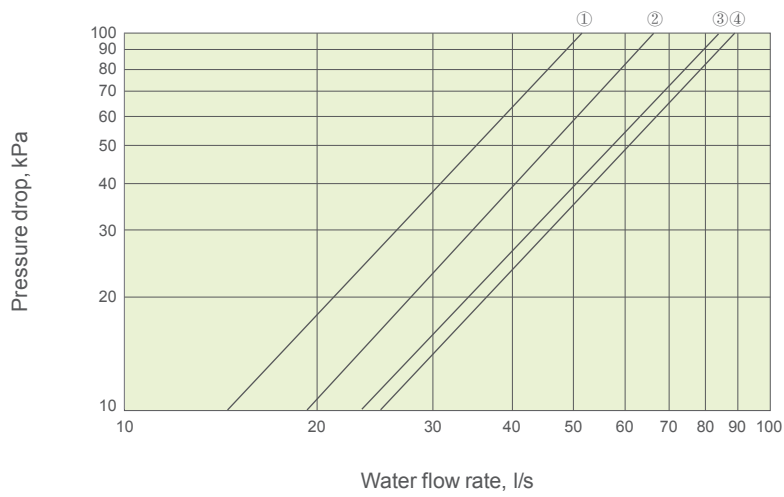

- ① 30XAV0682A
- ② 30XAV0862A
- ③ 30XAV1012A
- ④ 30XAV1162A

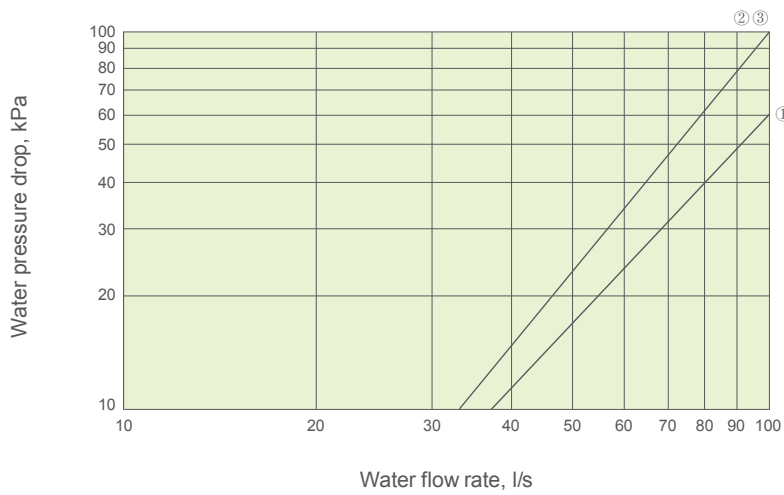

- ① 30XAV1232A
- ② 30XAV1302A
- ③ 30XAV1402A

## Minimum Water Loop Volume

For better control of leaving water temperature, the water loop minimum capacity is given by the formula:

$$\text{Capacity} = \text{CAP (kW)} \times \text{N Liters}$$

Application		N
Normal air conditioning	30XAV0332~1402A	3.5
Process cooling	30XAV0332~1402A	6.5

CAP is the nominal system cooling capacity (kW) at the nominal operating conditions of the installation.

This volume is necessary for stable operation and accurate temperature control.

It is often necessary to add a buffer water tank to the circuit in order to achieve the required volume. The tank must be internally baffled in order to ensure proper mixing of the liquid (water or brine). Refer to the following examples.

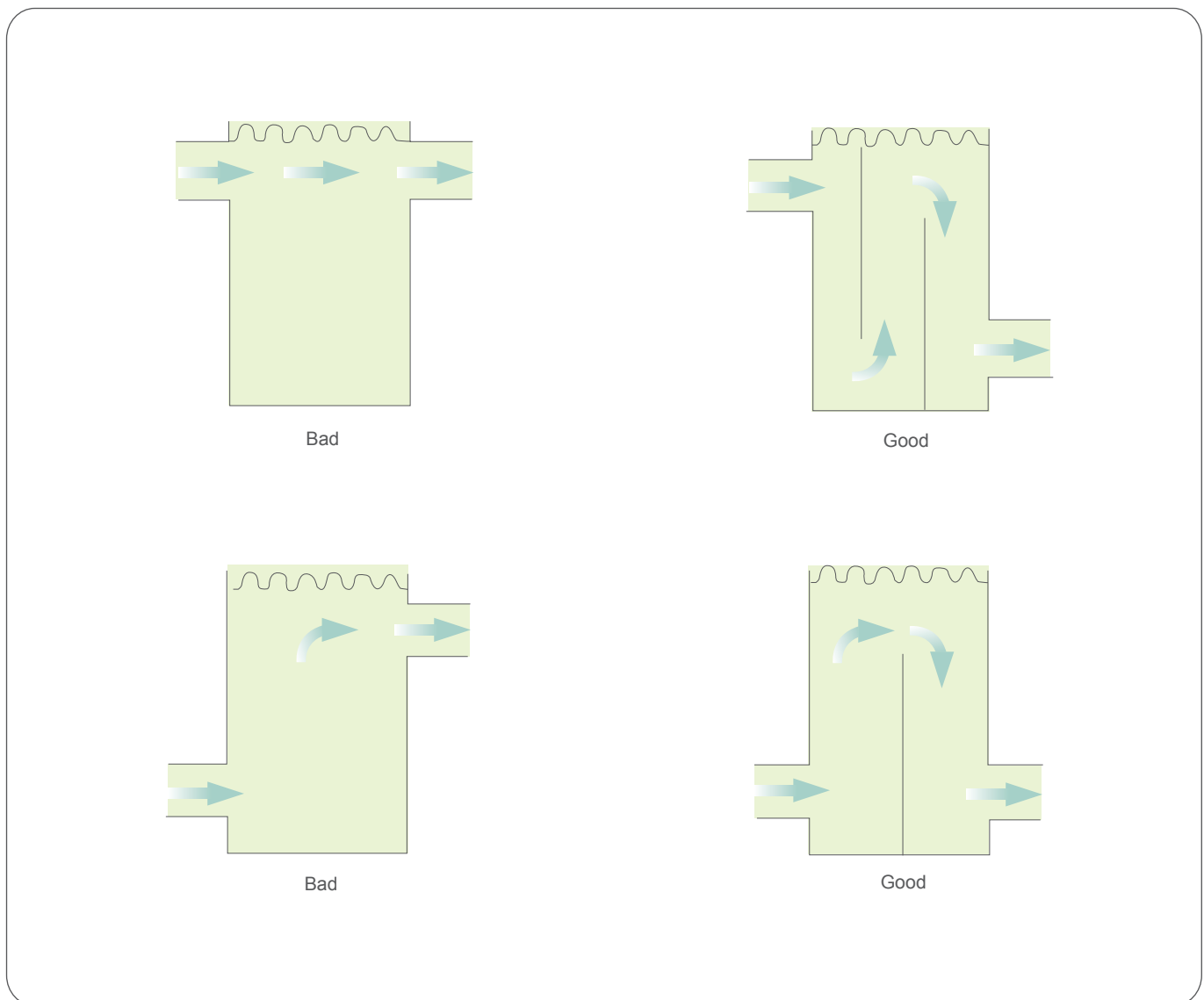



Carrier improves the world around us; Carrier improves people's lives; our products and services improve building performance; our culture of improvement will not allow us to rest when it comes to the environment.



[www.carrier.com](http://www.carrier.com)

The Manufacturer reserves the right to change any product specifications without prior notices  
© All Rights Reserved Carrier

Version:	CAT_30XAV_E-1911-12
Supersede:	CAT_30XAV_E-1909-11
Effective Date:	Nov, 2019